



AUSHÄNGBARE ALUMINIUM- SCHARNIERE 80 X 80 MM

14-7-3625

Stift aus verzinktem Stahl.
Nylonscheibe.

A	80 mm
Ausführung	Typ 2

Material	Aluminium
Gewicht (g)	85 g
B	80 mm
C	3.5 mm
S (Lochdurchmesser)	5.5 mm
D (Durchmesser)	8
Dekor	eloxiert Silber

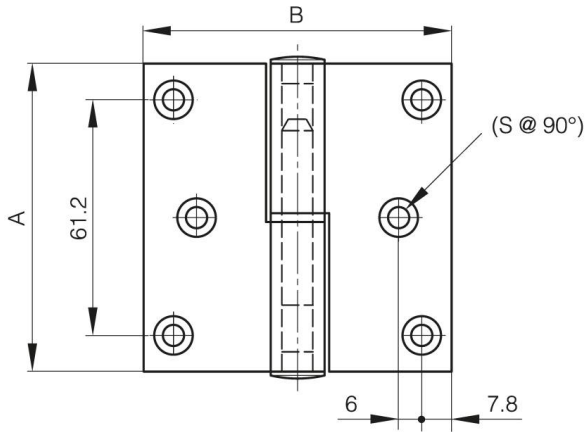

14-7-3624

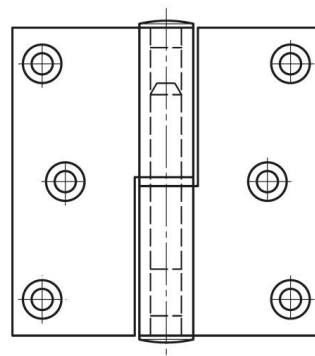

14-7-3625

