



AUSHÄNGBARE ALUMINIUM- SCHARNIERE 100 X 100 MM

14-7-3629

Stift aus verzinktem Stahl.
Nylonscheibe.

A	100 mm
Ausführung	Typ 2

Material	Aluminium
Gewicht (g)	106 g
B	100 mm
C	4 mm
S (Lochdurchmesser)	6 mm
D (Durchmesser)	9
Dekor	eloxiert Silber

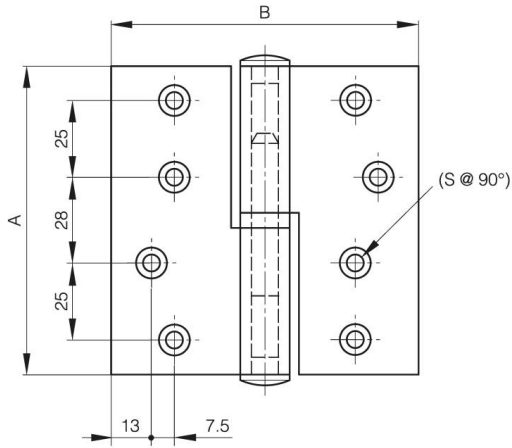

14-7-3628

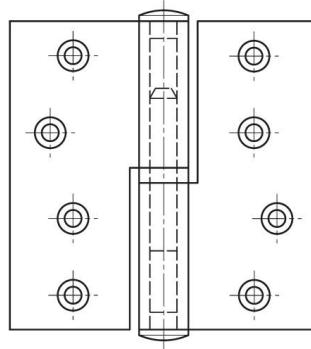

14-7-3629

