



KONSTRUKTIONSBÄNDER OHNE UNTERLEGSCHLEIFE MIT FLACHEN FLÜGELN

12-1-3308

A	60 mm
Ausführung	Typ 1

Material	Stahl
Gewicht (g)	39 g
B	40 mm
C	1.5 mm
E (Gelenkteile oder Dicke)	30 mm
D (Durchmesser)	5.3
Dekor	unbehandelt

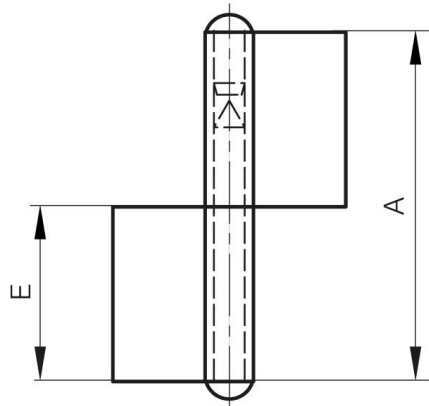

12-1-3308 & 12-1-3310

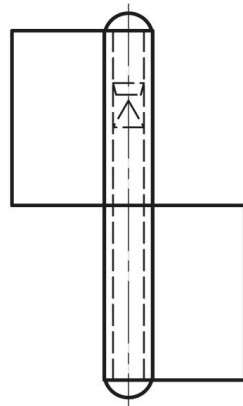

12-1-3307 & 12-1-3309

