



AUSHÄNGBARE SCHARNIERE LÄNGE VON 60 BIS 80 MM

14-7-3401

A	80 mm
Ausführung	Typ 2
Material	Stahl

Gewicht (g)	59 g
B	50 mm
C	1.5 mm
S (Lochdurchmesser)	4 mm
E (Gelenkteile oder Dicke)	7.2 mm
D (Durchmesser)	5
F (Abstand)	9.2 mm
G (Abstand)	62 mm
Dekor	vernickelt

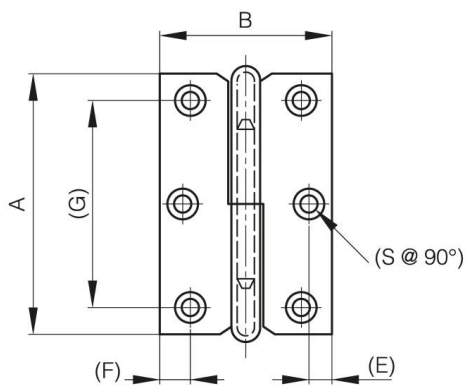

14-7-3396 & 14-7-3398 & 14-7-3400

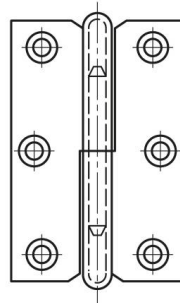

14-7-3397 & 14-7-3399 & 14-7-3401

