



## **BISAGRAS DE PASADOR OCULTAS CON RESORTE B**

**12-1-3951**

Resorte de acero inoxidable. Pasador cincado para bisagras en acero bruto y acero cincado. Pasador de acero inoxidable 304 para bisagras en acero inoxidable. Circlip en acero inoxidable 1.4122.

<b>A</b>	82 mm
<b>Nota</b>	tipo 1

<b>Material</b>	acero
<b>Peso (g)</b>	39 g
<b>B</b>	21 mm
<b>C</b>	14 mm
<b>D</b>	5
<b>Acabado</b>	crudo

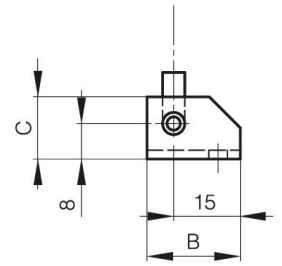
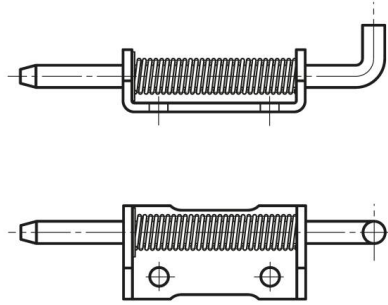
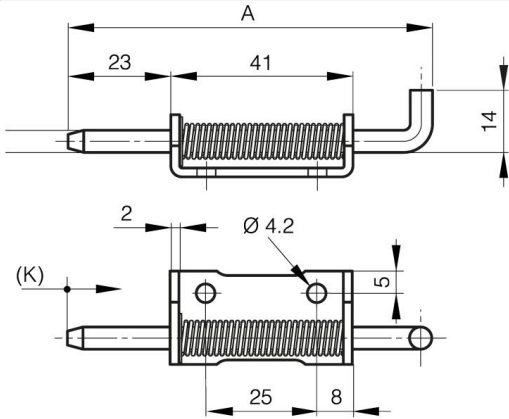

12-1-3951 & 12-1-3861 & 12-1-3863

12-1-3950 & 12-1-3860 & 12-1-3862

<b>K</b>	12 mm
----------	-------