



BISAGRAS DE PASADOR OCULTAS CON RESORTE B

12-1-3862

Resorte de acero inoxidable. Pasador cincado para bisagras en acero bruto y acero cincado. Pasador de acero inoxidable 304 para bisagras en acero inoxidable. Circlip en acero inoxidable 1.4122.

A	82 mm
Nota	tipo 2

Material	acero inoxidable 304
Peso (g)	39 g
B	21 mm
C	14 mm
D	5
Acabado	crudo

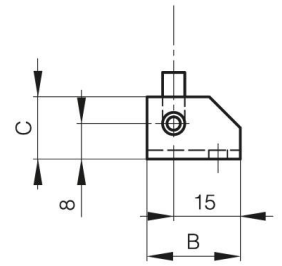
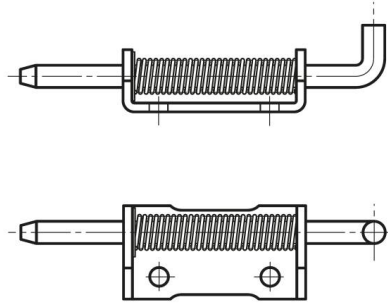
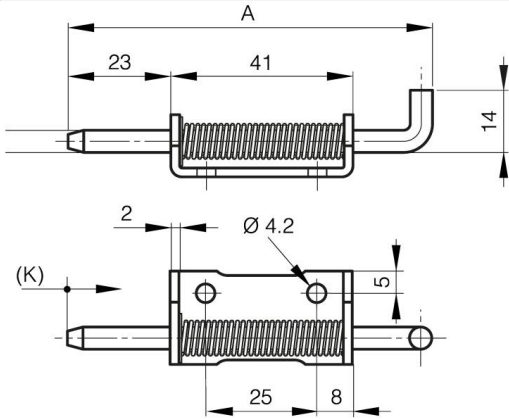

12-1-3951 & 12-1-3861 & 12-1-3863

12-1-3950 & 12-1-3860 & 12-1-3862

K	12 mm
----------	-------