



BISAGRAS DESMONTABLES DE ALUMINIO 80 X 80 MM

14-7-3625

Pasador de acero cincado. Casquillo de nylon.

A	80 mm
Nota	tipo 2

Material	aluminio
Peso (g)	85 g
B	80 mm
C	3.5 mm
S (diamètre trou)	5.5 mm
D	8
Acabado	anodizado natural

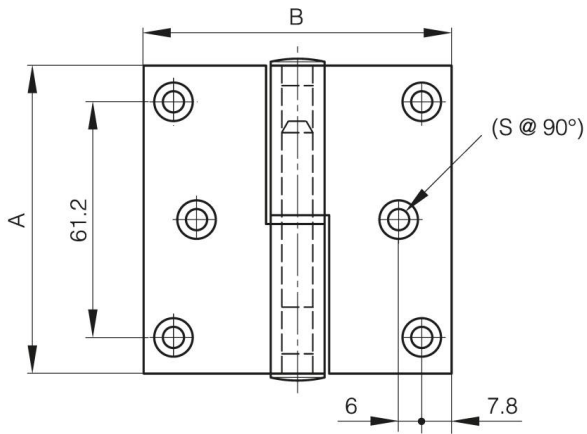

14-7-3624

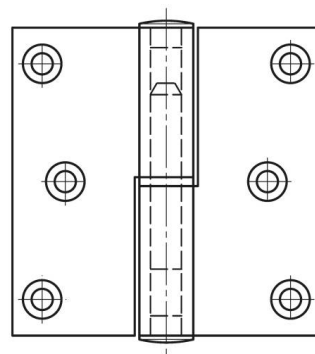

14-7-3625

