



BISAGRAS DESMONTABLES 80 X 80 MM - ACERO INOXIDABLE CON 6 AGUJEROS

14-7-3728

Sólo el lado visible tiene un acabado cepillado. Producido principalmente en acero inoxidable, para una descripción completa de los materiales contáctenos.

A	80 mm
Nota	tipo 2 / esquinas cuadradas

Material	acero inoxidable 304
Peso (g)	175 g
B	80 mm
C	2.5 mm
S (diamètre trou)	5.8 mm
D	7
Acabado	cepillado

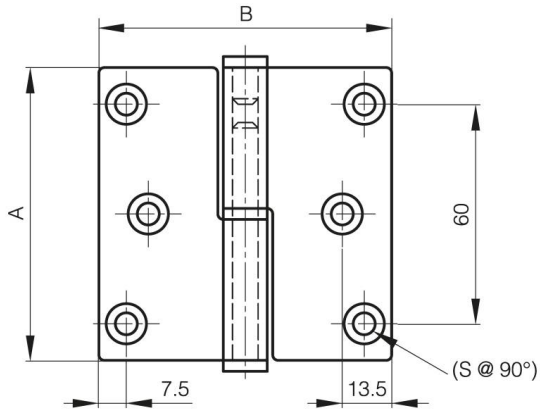

14-7-3727

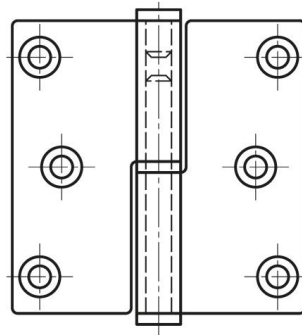

14-7-3728

