



BISAGRAS DESMONTABLES DE 60 A 80 MM DE LARGO

14-7-3401

A	80 mm
Nota	tipo 2
Material	acero

Peso (g)	59 g
B	50 mm
C	1.5 mm
S (diamètre trou)	4 mm
E	7.2 mm
D	5
F	9.2 mm
G	62 mm
Acabado	niquelado

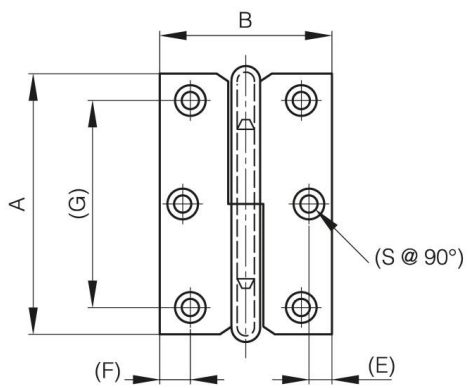

14-7-3396 & 14-7-3398 & 14-7-3400

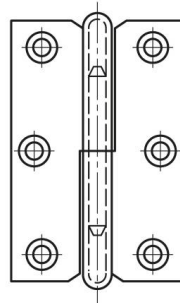

14-7-3397 & 14-7-3399 & 14-7-3401

