



BISAGRA DESMONTABLE CON CASQUILLO DE POLÍMERO

14-7-3902

Bisagra probada según EN1935: 2002 grados 13-14. Recomendado para pesos de puerta inferiores a 160 kg, uso anual hasta 200.000 ciclos. Espesor de puerta: 44 mm a 54 mm. Versión de bisagra estándar 52-7-4132.

A	101.6 mm
Nota	Tipo 2

Material	acero inoxidable 304
Peso (g)	255 g
B	88.9 mm
C	3 mm
S (diamètre trou)	8.5 mm
D	7
Acabado	pulido satinado
Nouvelle référence	NEW

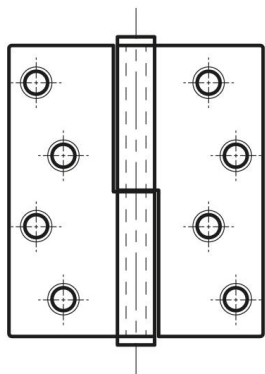

52-7-3902

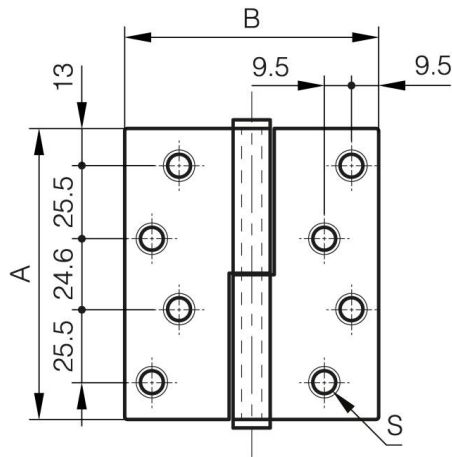

52-7-3903

