

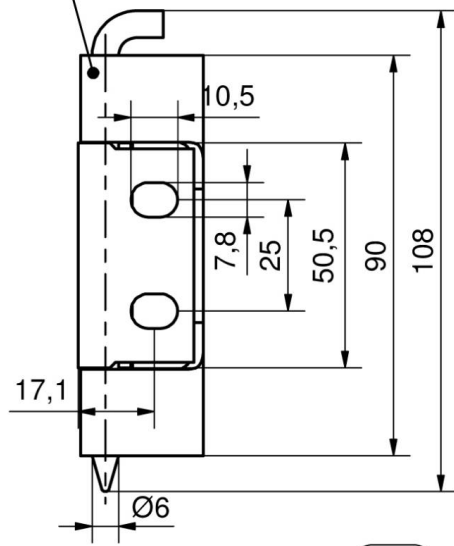

**CHARNIERE 120° RENFORCEE INOX TROU
VF M6 + ROND. AVEC GAGES CIRCLIPS**

85-7-2215

a), d), g)



b), e), h)

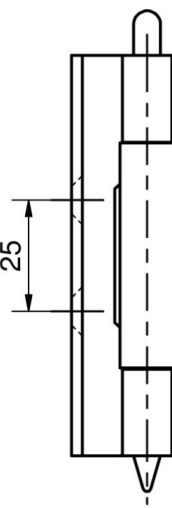

c), f), i)

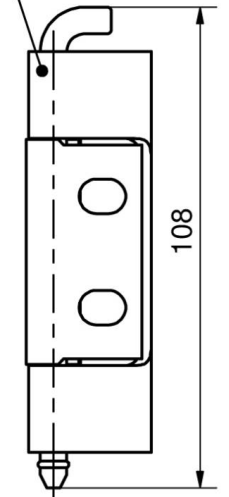
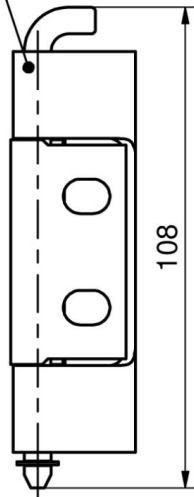

a) - c)

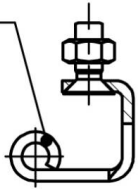

d) - f)

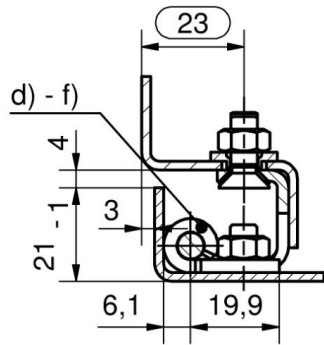

g) - i)

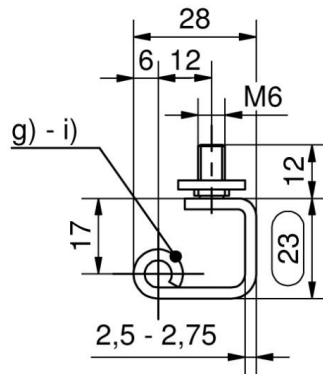

1.

