



FITSCHEN MIT UNTERLEGSCHLEIFE, FLACHEM GELENK

12-1-3312

Fitschen mit Messingunterlegscheibe, separat verpackt.

A (Länge)	61.5 mm
Ausführung	Typ 1

Material	Stahl
Gewicht (g)	40 g
B	40 mm
C	1.5 mm
E	30 mm
D (Durchmesser)	5.2

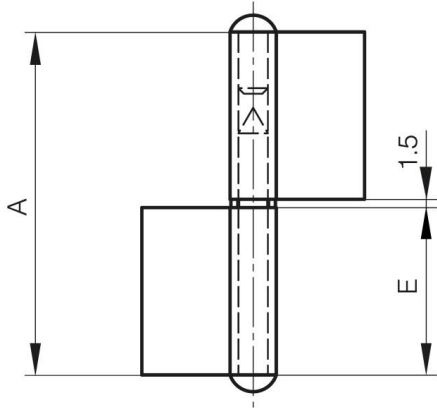

12-1-3312 & 12-1-3314

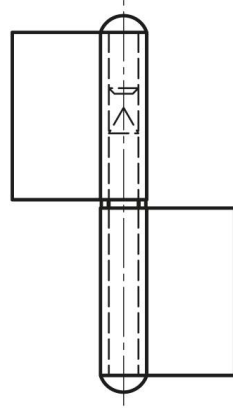

12-1-3311 & 12-1-3313

