



CONCEALED SPRINGLOADED PIN HINGES B

12-1-3860

Stainless steel spring.

Zinc plated pin for hinges in raw steel and zinc plated steel.

304 stainless steel pin for hinges in stainless steel.

Circlip in 1.4122 stainless steel.

A (length)	82 mm
-------------------	-------

Note	type 2
Material	steel
Weight (g)	39 g
B (width)	21 mm
C	14 mm
D (pin diameter)	5

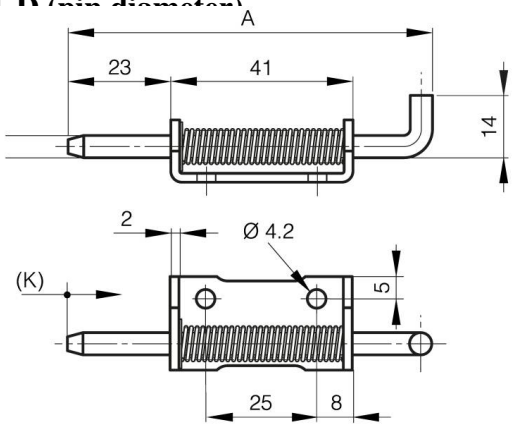

12-1-3951 & 12-1-3861 & 12-1-3863

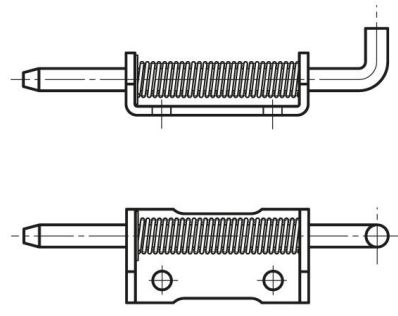

12-1-3950 & 12-1-3860 & 12-1-3862

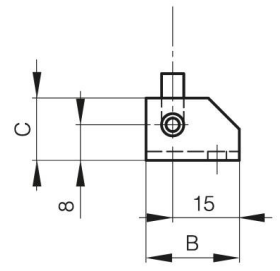

K	12 mm
----------	-------