



LIFT-OFF HINGES 100 X 82 MM - STAINLESS STEEL WITH 8 HOLES

14-7-3679

Only the visible side has a brushed finish.

Produced mainly in stainless steel, for a complete description of the materials contact us.

A (length)	100 mm
Note	type 2 / square corners

Material	304 stainless steel
Weight (g)	220 g
B (width)	82 mm
C	2.5 mm
S	6 mm
D (pin diameter)	7

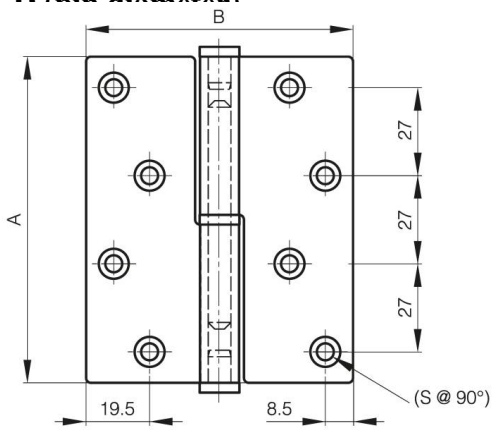

14-7-3675

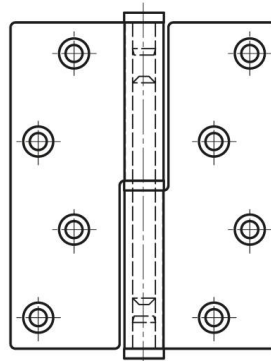

14-7-3679

