



LIFT-OFF HINGES 60 TO 80 MM LONG

14-7-3399

A (length)	68 mm
Note	type 2
Material	steel
Weight (g)	46 g

B (width)	45 mm
C	1.5 mm
S	4.5 mm
E	6 mm
D (pin diameter)	4.5
F (pitch)	8 mm
G (pitch)	54 mm

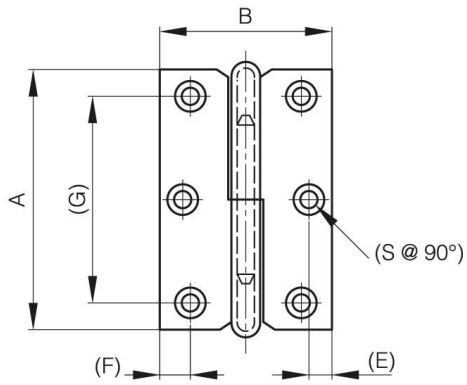

14-7-3396 & 14-7-3398 & 14-7-3400

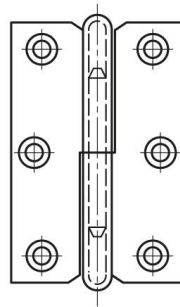

14-7-3397 & 14-7-3399 & 14-7-3401

