



SPRING HINGES - ALUMINIUM PROFILE 1.3 N.M - DIAMETER 13

72-1-4297

Opening spring force:

M(0°): 1.3 N.m / M(90°): 1.1 N.m / M(180°): 0.9 N.m

Closing spring force:

M(0°): 0.5 N.m / M(90°): 0.7 N.m / M(180°): 1 N.m

3 other versions available: free swinging, with friction or with detent mechanism.

A (length)	67 mm
Note	opening spring / delivered flat
Material	6060 T5 alu
Weight (g)	68 g
B (width)	55 mm
C	4.5 mm
D (pin diameter)	12

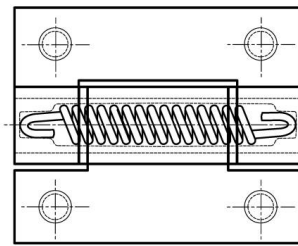
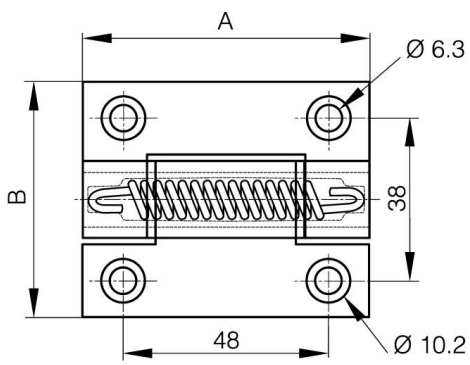

72-1-4320 & 72-1-4321
72-1-4327 & 72-1-4328

