



## **BISAGRAS DESMONTABLES DE ALUMINIO 80 X 80 MM**

**14-7-3625**

Pasador de acero cincado. Casquillo de nylon.

<b>A</b>	80 mm
<b>Nota</b>	tipo 2

<b>Material</b>	aluminio
<b>Peso (g)</b>	85 g
<b>B</b>	80 mm
<b>C</b>	3.5 mm
<b>S (diamètre trou)</b>	5.5 mm
<b>D</b>	o

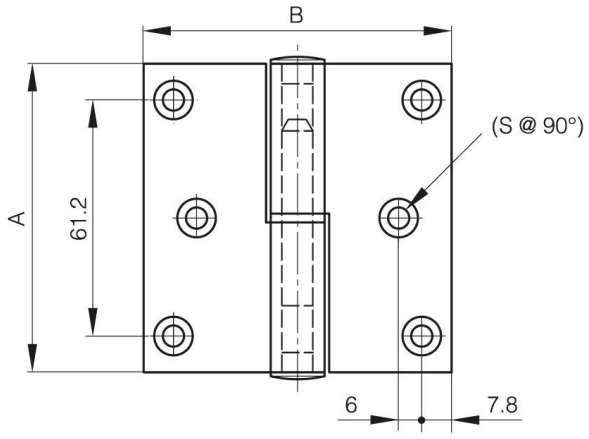

14-7-3624

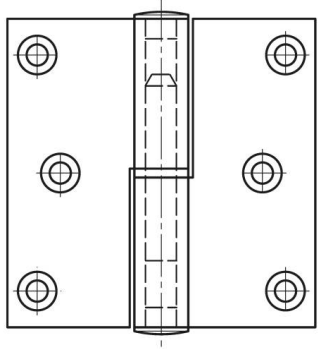

14-7-3625

