



BISAGRAS DESMONTABLES DE PLÁSTICO.

14-7-3723

Las bisagras están fabricadas con un 15% de poliamida GF y los pasadores son de acero inoxidable 303.

A	74 mm
Nota	tipo 2
Material	poliamida

Peso (g)	53 g
B	60 mm
C	7 mm
S (diamètre trou)	5 mm
D	0.5

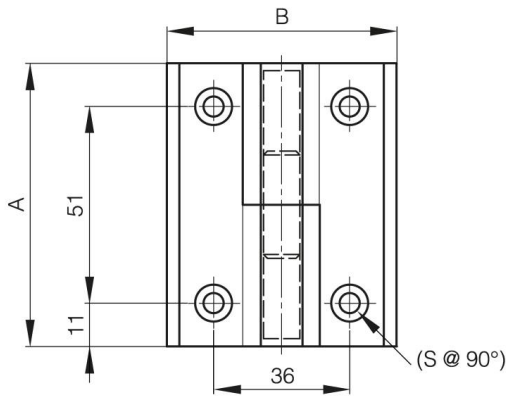

14-7-3722

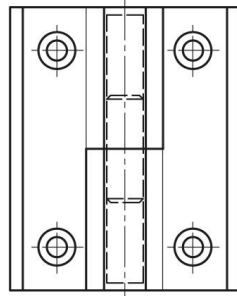

14-7-3723

