



BISAGRAS DE RESORTE - PERFIL DE ALUMINIO 0,70 NM - DIÁMETRO 13

72-1-4374

Fuerza del resorte de apertura: M(0°): 0,7 Nm / M(90°): 0,45 Nm / M(180°): 0,23 Nm Fuerza del resorte de cierre: M(0°): 0,23 Nm / M(90°): 0,45 Nm / M(180°): 0,7 Nm 3 otras versiones disponibles: de giro libre, con fricción o con mecanismo de retención.

A	67 mm
----------	-------

Nota	resorte de apertura/ entregado plano
Material	6060 T5 aluminio
Peso (g)	66 g
B	55 mm
C	4.5 mm
D	13
Acabado	anodizado azul

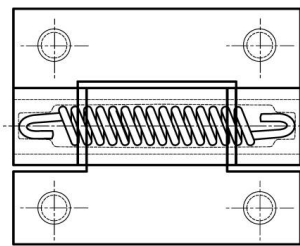
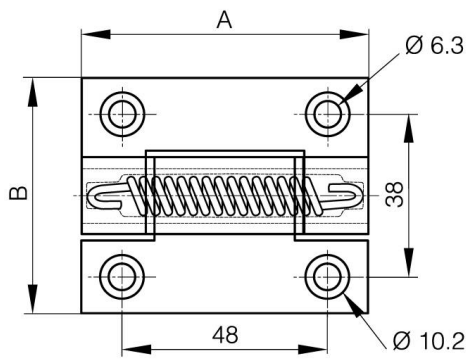

72-1-4322 & 72-1-4325
72-1-4326 & 72-1-4335

