

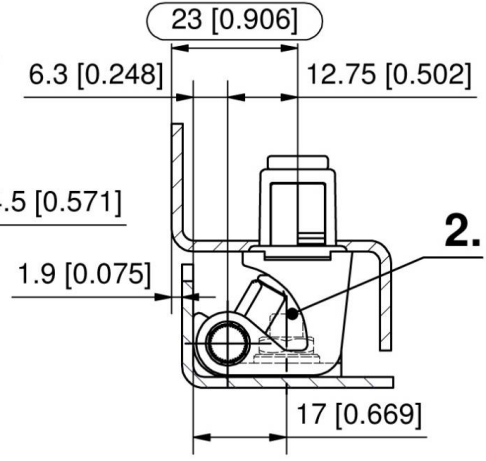

## **CHARNIERE 130° SL 1,2-1,7 V2**

**85-7-6228**

---

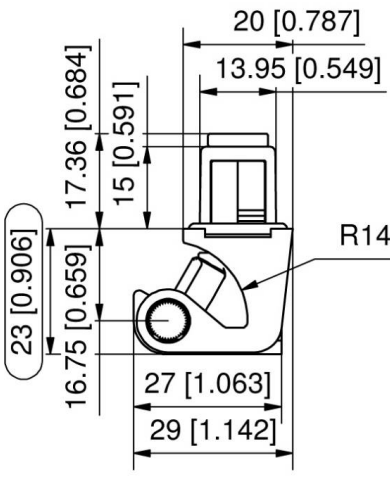
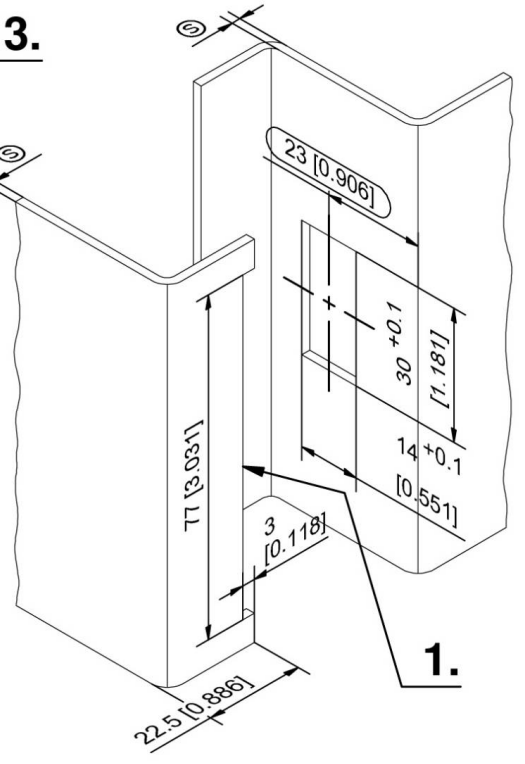
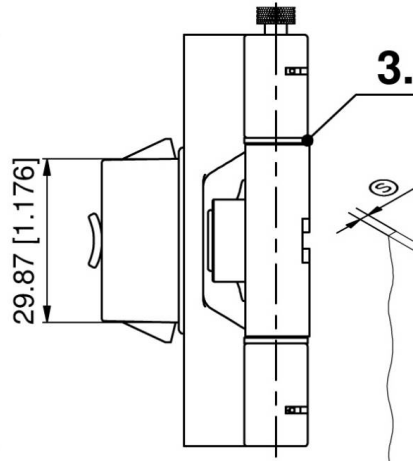
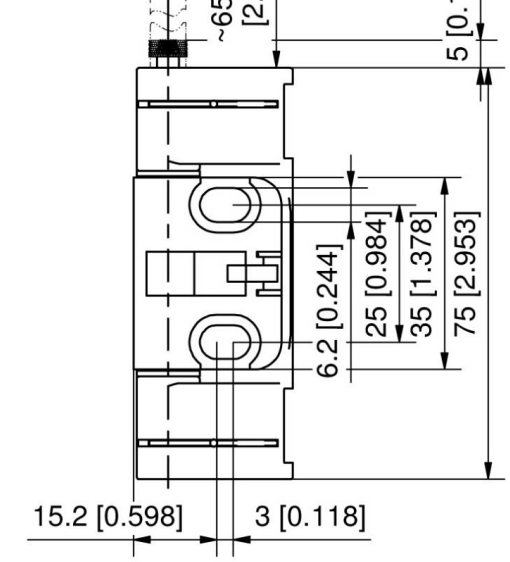

2.