

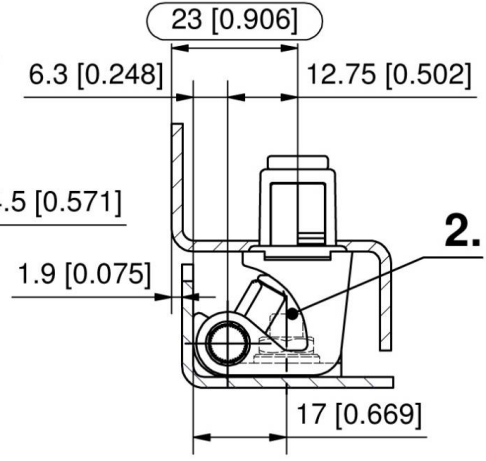

## **CHARNIERE 130° SL 2,7-3,2 V2**

**85-7-6231**

---

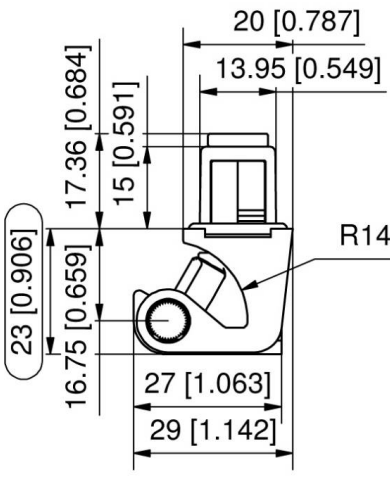
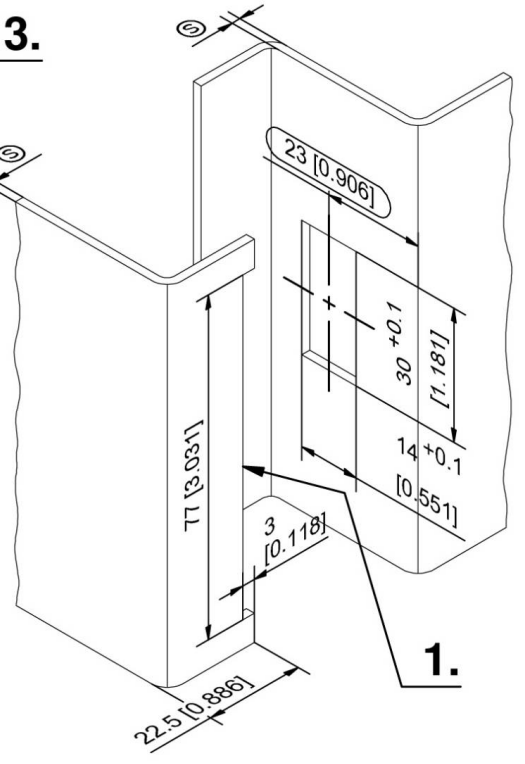
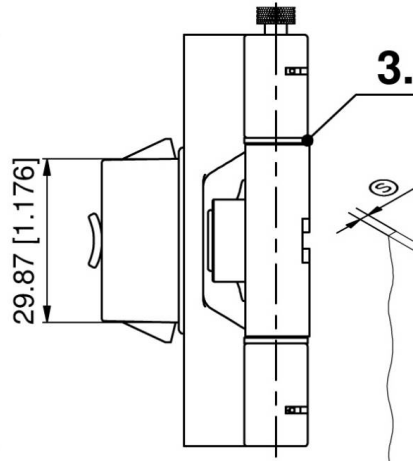
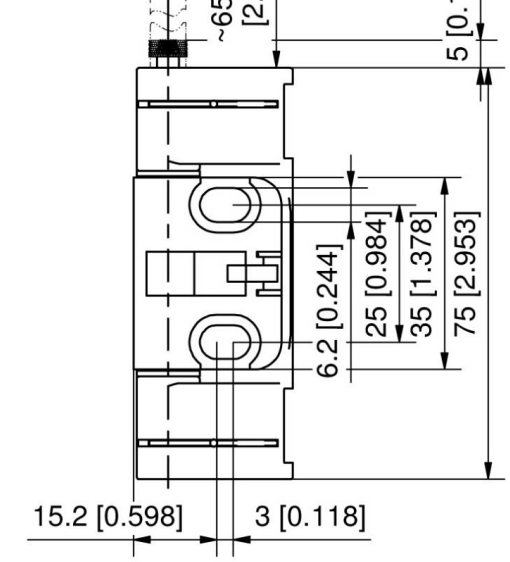

2.