



PAUMELLES EN PLASTIQUE

14-7-3723

Paumelles en polyamide chargé 15% fibre de verre, broche en inox 303.

A (longueur)	74 mm
Note	type 2
Matière	polyamide

Poids (g)	53 g
B (largeur)	60 mm
C (épaisseur)	7 mm
S (diamètre trou)	5 mm
D (diamètre broche ou file)	0.5

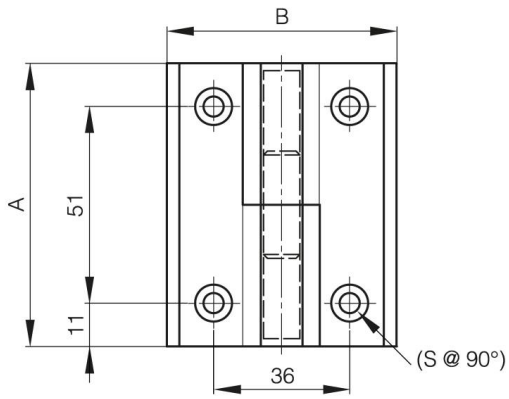

14-7-3722

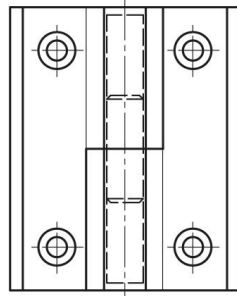

14-7-3723

