



PAUMELLES LONGUEUR 60 À 80 MM

14-7-3399

A (longueur)	68 mm
Note	type 2
Matière	acier
Poids (g)	46 g

B (largeur)	45 mm
C (épaisseur)	1.5 mm
S (diamètre trou)	4.5 mm
E (Charnon ou épaisseur)	6 mm
D (diamètre broche ou fil)	4.5
F (entraxe)	8 mm
G (esp. des trous)	5.1 mm

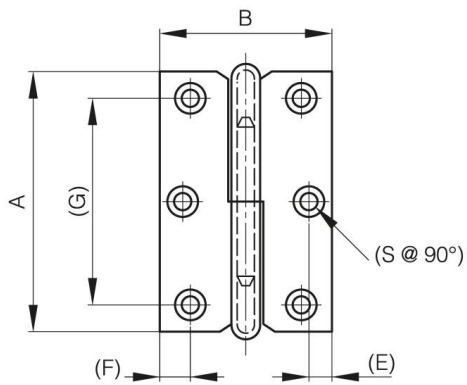

14-7-3396 & 14-7-3398 & 14-7-3400

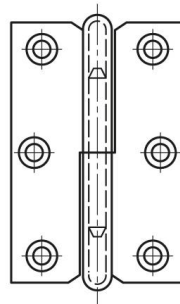

14-7-3397 & 14-7-3399 & 14-7-3401

