



PAUMELLES LONGUEUR 60 À 80 MM

14-7-3401

A (longueur)	80 mm
Note	type 2
Matière	acier
Poids (g)	59 g

B (largeur)	50 mm
C (épaisseur)	1.5 mm
S (diamètre trou)	4 mm
E (Charnon ou épaisseur)	7.2 mm
D (diamètre broche ou fil)	5
F (entraxe)	9.2 mm
G (esp. des trous)	62 mm

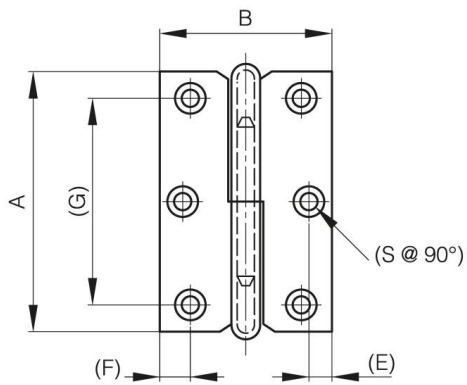

14-7-3396 & 14-7-3398 & 14-7-3400

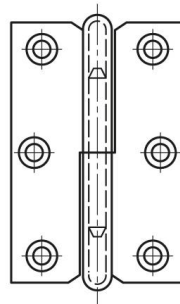

14-7-3397 & 14-7-3399 & 14-7-3401

