

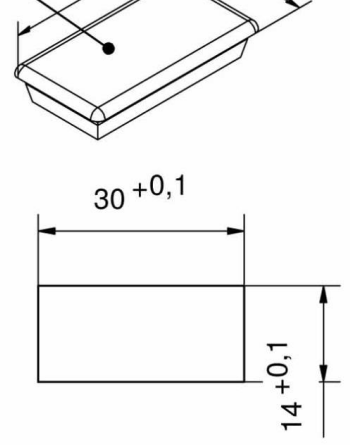

BOUCHON NBR SNAP-LINE 25X10

87-7-6091

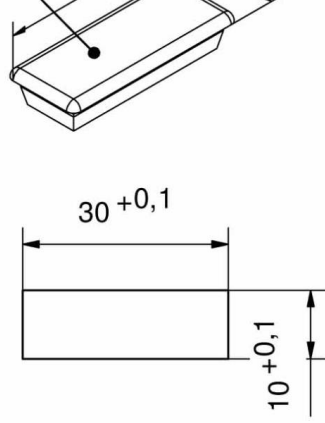
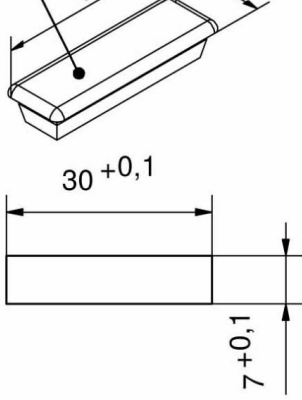

d), e)

