

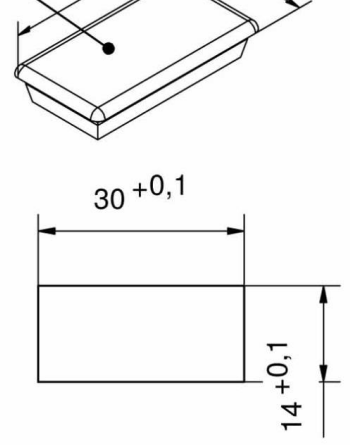

## **BOUCHON NBR SNAP-LINE 25X10**

**87-7-6092**

---

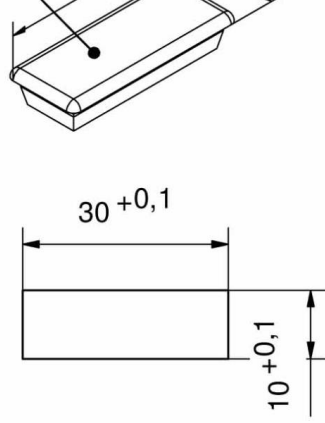
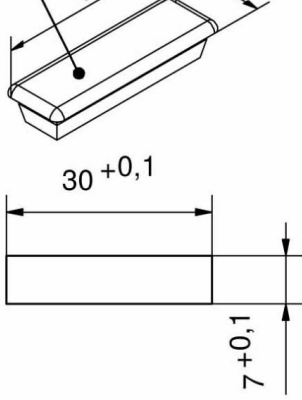

**d), e)**

