

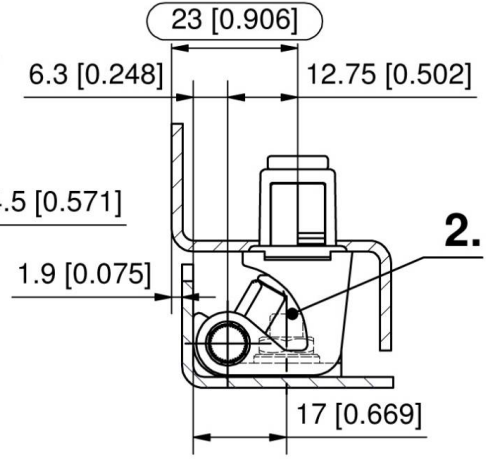

CHARNIERE 130° SL 1,7-2,2 V2

85-7-6229

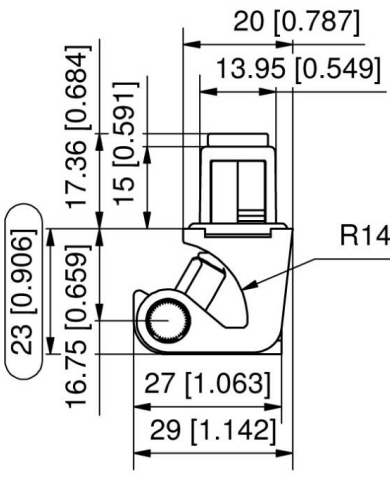
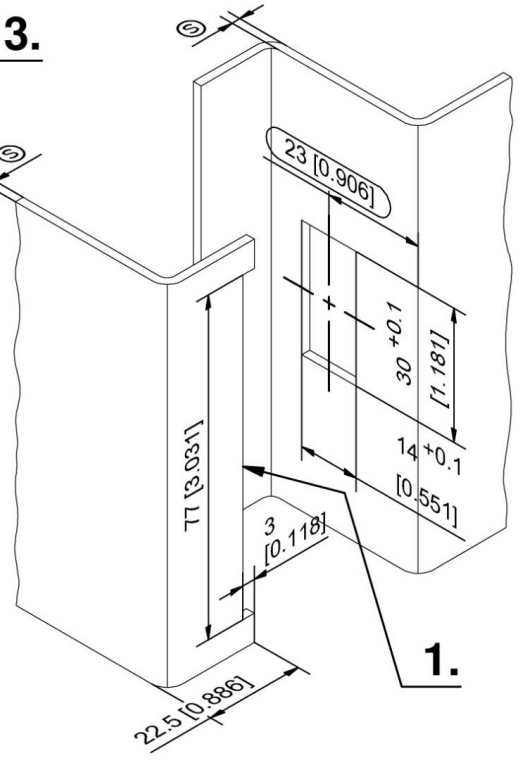
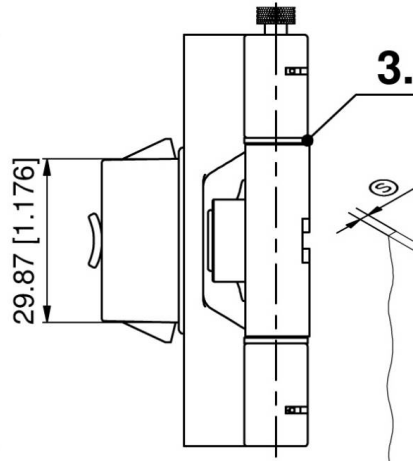
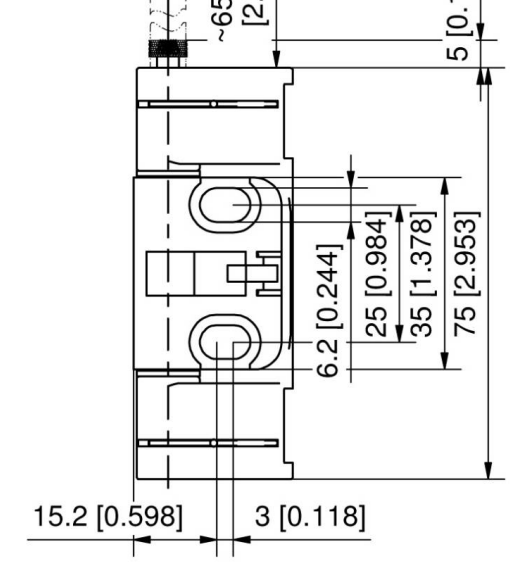

2.