

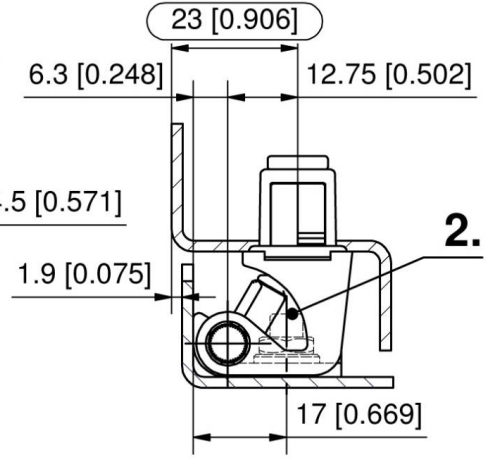

CHARNIERE 130° SL 2,7-3,2 V2

85-7-6231

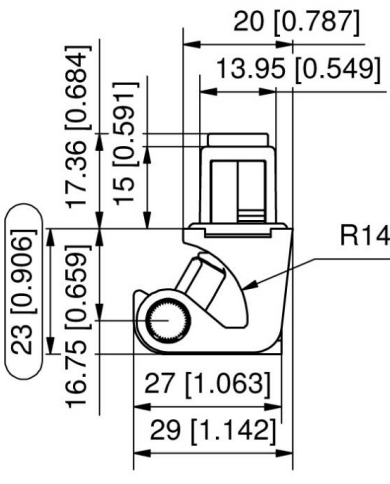
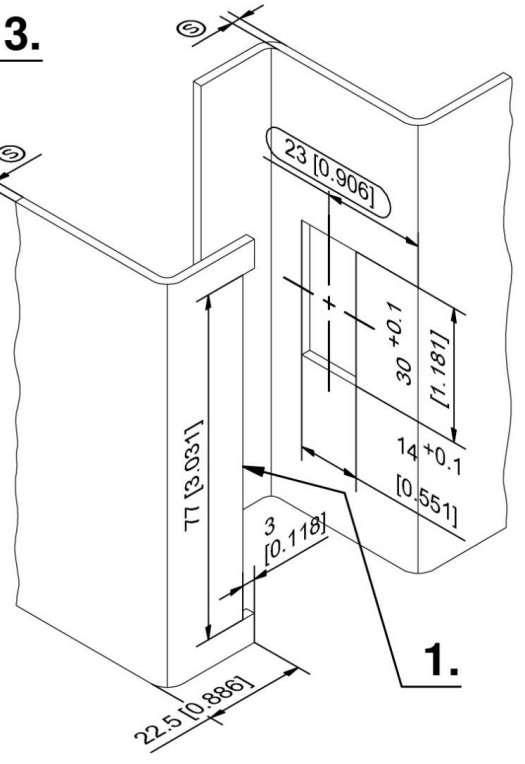
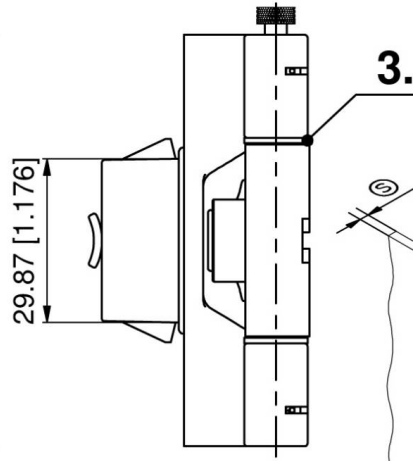
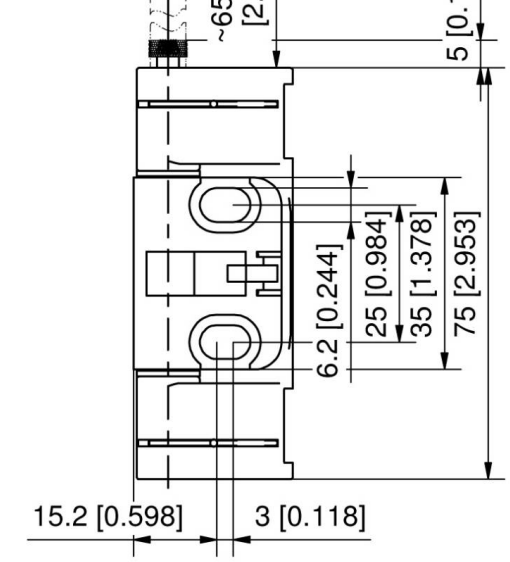

2.