

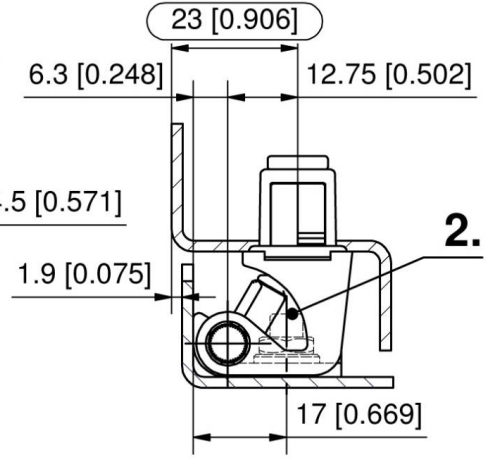

CHARNIERE 130° SL 3,0-3,5 V2

85-7-6232

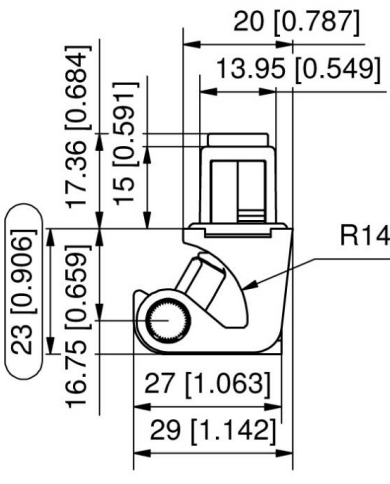
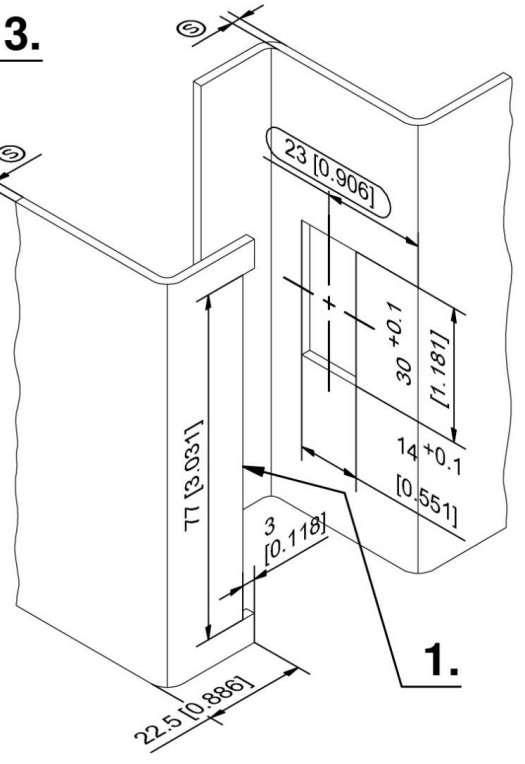
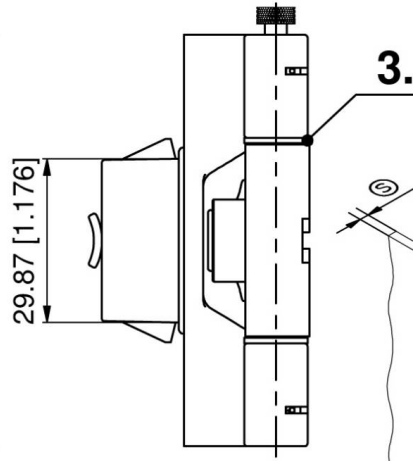
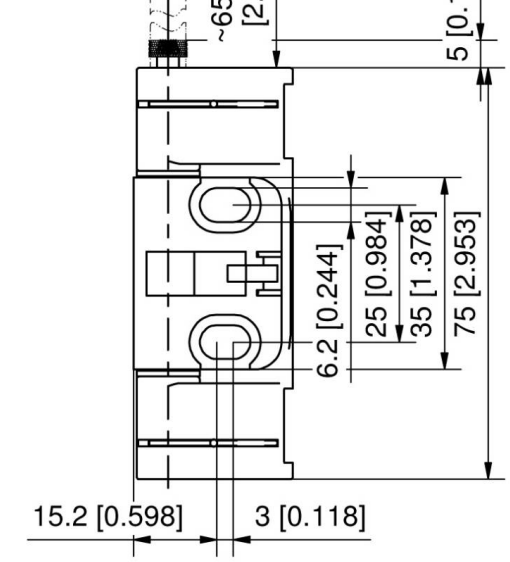

2.