



CERNIERE IN POLIAMMIDE SFILABILI

14-7-3723

Le cerniere sono realizzate in poliammide 15% GF, i perni sono in acciaio inossidabile 303.

A	74 mm
Nota	tipo 2
Materiale	poliammide

Peso (g)	53 g
B	60 mm
C	7 mm
S (diamètre trou)	5 mm
D	0.5

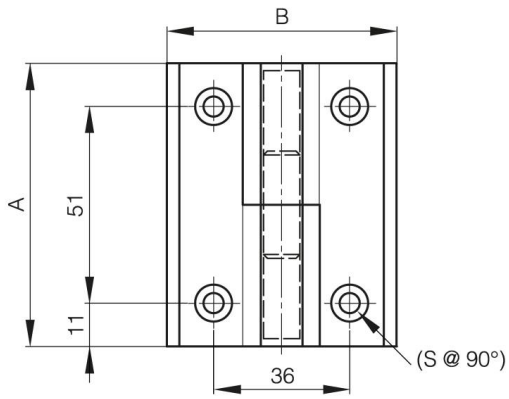

14-7-3722

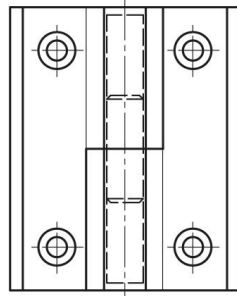

14-7-3723

