

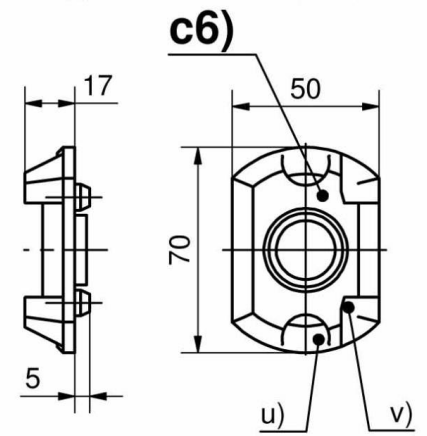

ROSACE SANS BUTEE

87-7-3537

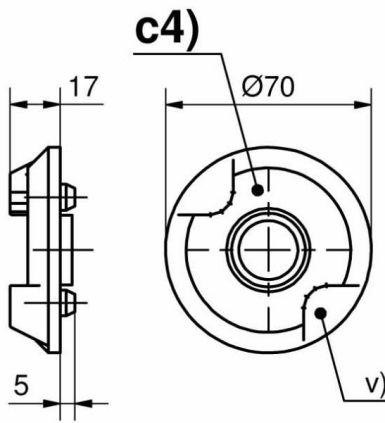
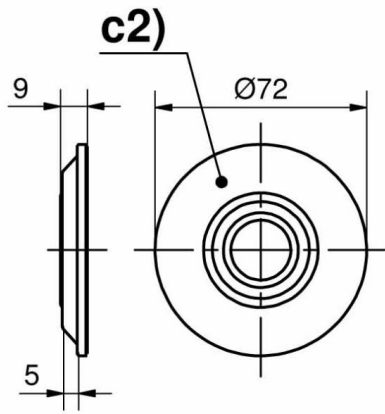
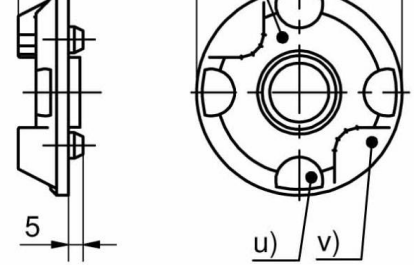
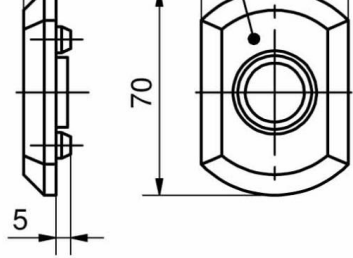
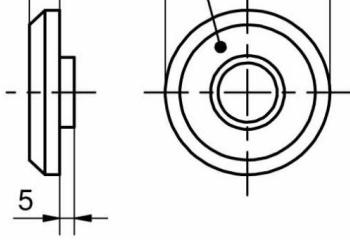

für c1)

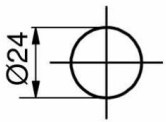

für c2)

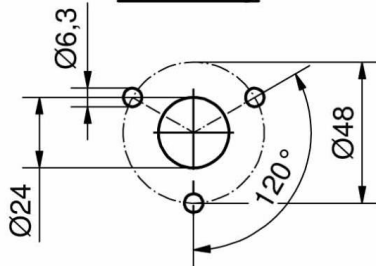

für c3), c4), c5) und c6)

