

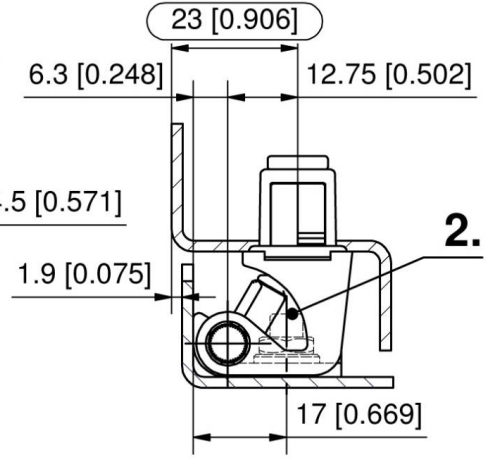

CHARNIERE 130° SL 2,2-2,7 V2

85-7-6230

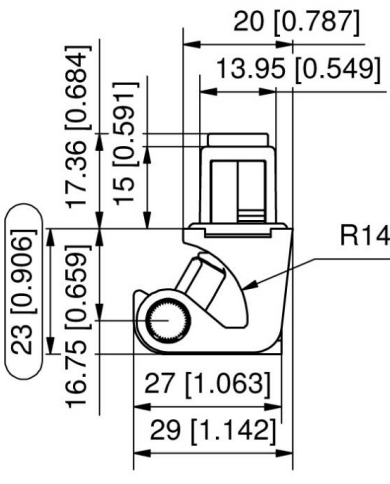
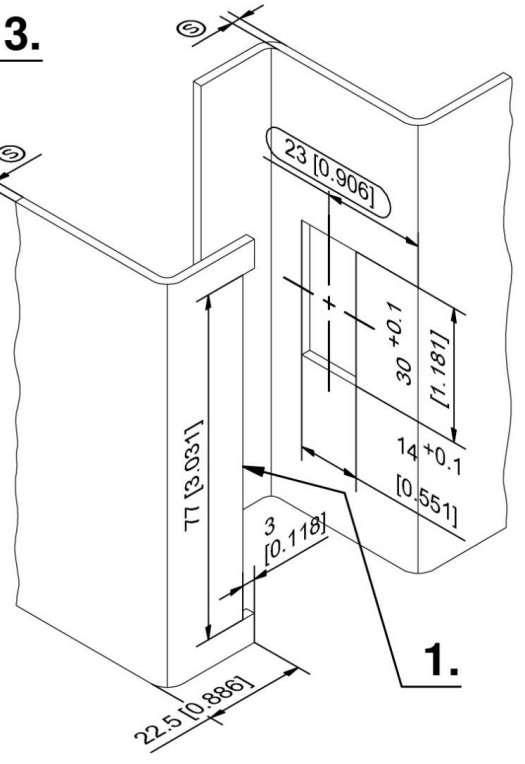
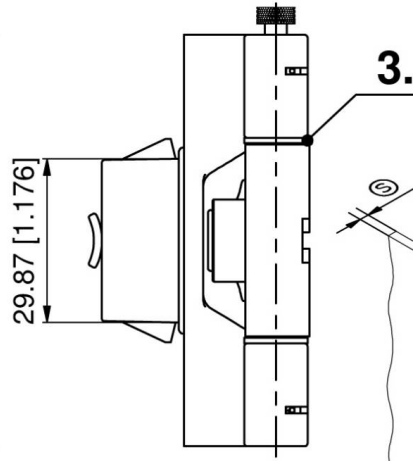
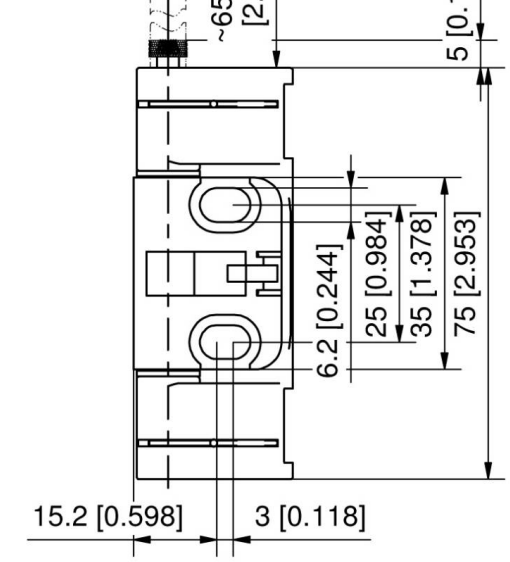

2.