



CERNIERE CON PERNO A MOLLA NASCOSTA B

12-1-3861

Molla in acciaio inossidabile. Perno zincato per cerniere in acciaio grezzo e acciaio zincato. Perno in acciaio inossidabile 304 per cerniere in acciaio inossidabile. Anello elastico in acciaio inossidabile 1.4122.

A	82 mm
Nota	tipo 1

Materiale	acciaio
Peso (g)	39 g
B	21 mm
C	14 mm
D	5
Finitura	zincato

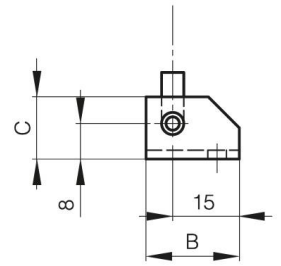
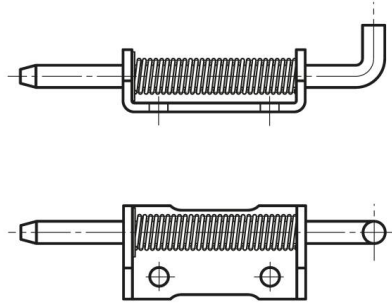
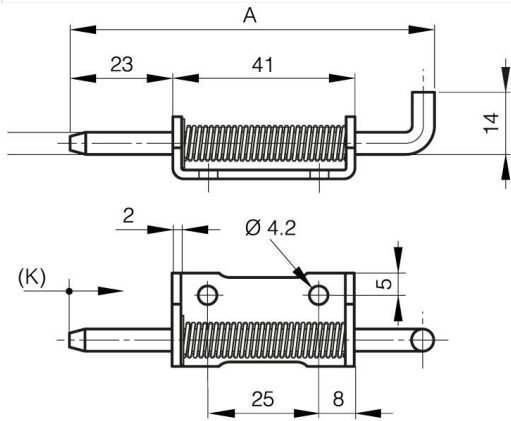

12-1-3951 & 12-1-3861 & 12-1-3863

12-1-3950 & 12-1-3860 & 12-1-3862

K	12 mm
----------	-------