



CERNIERE SFILABILI IN ALLUMINIO 80 X 80 MM

14-7-3625

Perno in acciaio zincato. Boccola in nylon.

A	80 mm
Nota	tipo 2

Materiale	alluminio
Peso (g)	85 g
B	80 mm
C	3.5 mm
S (diamètre trou)	5.5 mm
D	8
Finitura	argento anodizzato

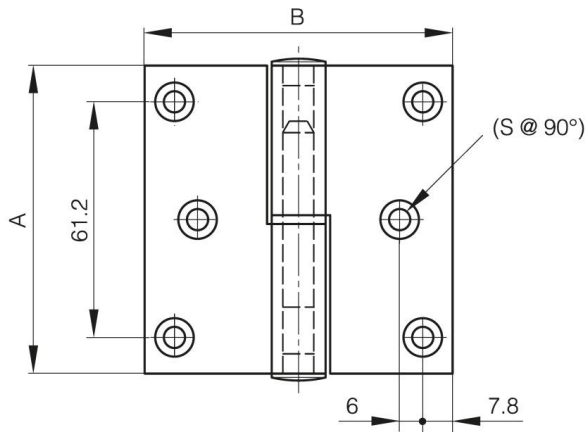

14-7-3624

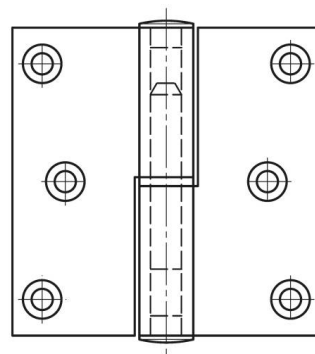

14-7-3625

