



CERNIERE SFILABILI 80 X 80 MM - ACCIAIO INOSSIDABILE A 6 FORI

14-7-3728

Solo il lato a vista ha finitura spazzolata. Prodotto principalmente in acciaio inossidabile, per una descrizione completa dei materiali contattateci.

A	80 mm
Nota	tipo 2 / angoli squadrati

Materiale	acciaio inossidabile 304
Peso (g)	175 g
B	80 mm
C	2.5 mm
S (diamètre trou)	5.8 mm
D	7
Finitura	spazzolato

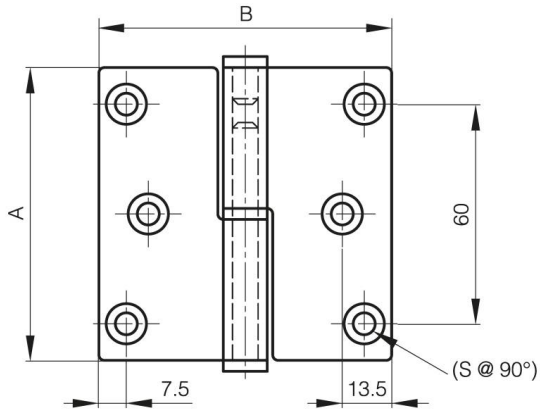

14-7-3727

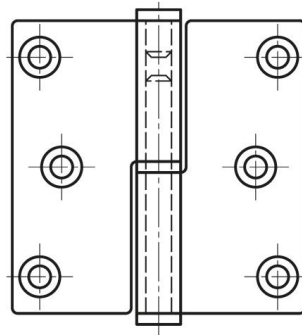

14-7-3728

