



CERNIERE SFILABILI IN PRESSOFUSIONE DI ZINCO 64 X 50 MM

72-1-9003

Rondella in nylon. Perno in acciaio.

A	64 mm
Nota	tipo 1

Materiale	pressofuso di zinco
Peso (g)	247 g
B	50 mm
C	17.5 mm
Finitura	nero

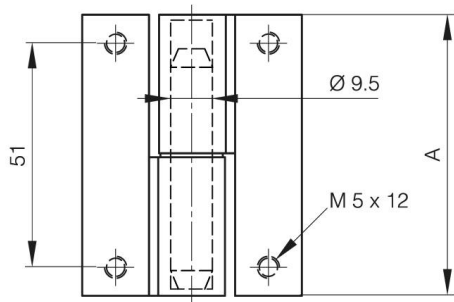

72-1-9003

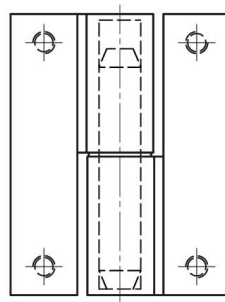

72-1-9002

