



CERNIERE A MOLLA - PROFILO ALLUMINIO 0,70 NM - DIAMETRO 13

72-1-4272

Forza della molla di apertura: $M(0^\circ)$: 0,7 Nm / $M(90^\circ)$: 0,45 Nm / $M(180^\circ)$: 0,23 Nm Forza della molla di chiusura: $M(0^\circ)$: 0,23 Nm / $M(90^\circ)$: 0,45 Nm / $M(180^\circ)$: 0,7 Nm Altre 3 versioni disponibili: oscillazione libera, con frizione o con meccanismo di arresto.

A

67 mm

Nota	molla di chiusura
Materiale	6060 T5 alluminio
Peso (g)	65 g
B	55 mm
C	4.5 mm
D	13
Finitura	anodizzato chiaro

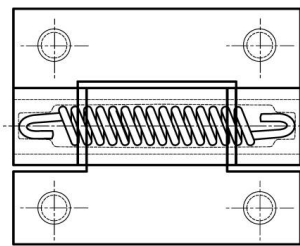
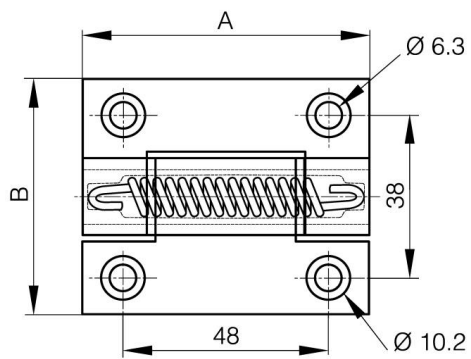

72-1-4322 & 72-1-4325
72-1-4326 & 72-1-4335

