



CHIUSURE A MOLLA NASCOSTE

16-1-4340

Chiusure a scatto.

A	35 mm
Materiale	acciaio
Peso (g)	20 g

B	36.5 mm
C	1.2 mm
S (diamètre trou)	3.5 mm
E	11 mm
D	1
F	13.5 mm
G	23 mm
H	23.1 mm
Finitura	zincato
J	8 mm
Nouvelle référence	NEW

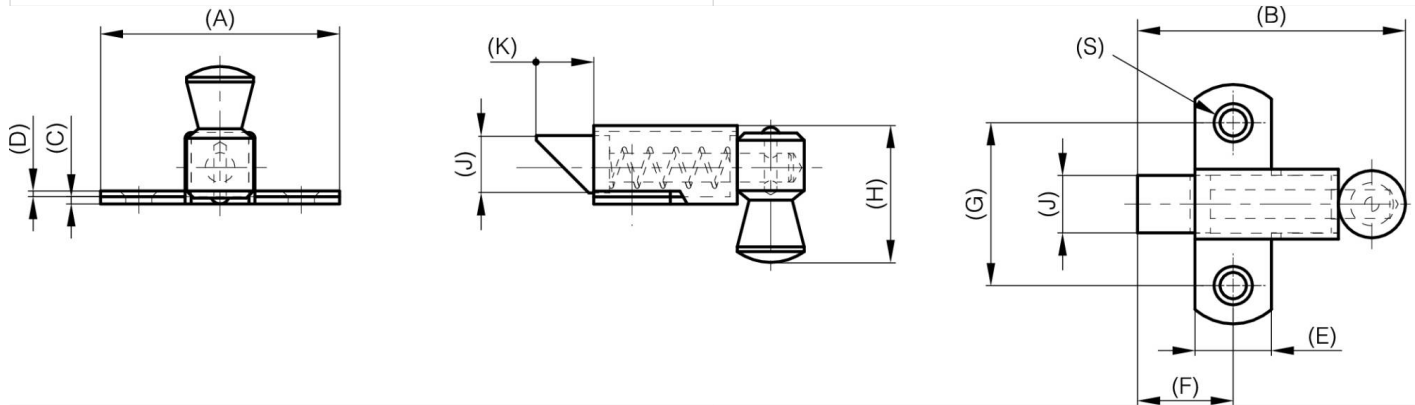

K	8 mm
----------	------