



CHIUSURE A MOLLA NASCOSTE

16-1-4344

Chiusure a scatto.

A	50 mm
Materiale	acciaio
Peso (g)	71 g

B	56 mm
C	1.5 mm
S (diamètre trou)	5.5 mm
E	16 mm
D	1.2
F	20 mm
G	34 mm
H	32.8 mm
Finitura	zincato
J	12 mm
Nouvelle référence	NEW

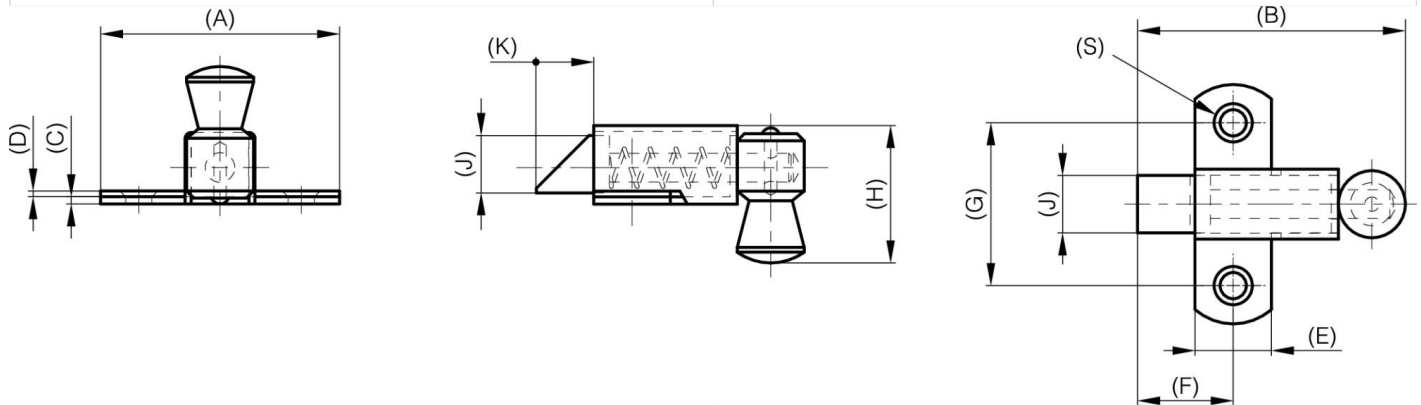

K	12 mm
----------	-------